



HORECAPROFESSIONALS

STRONGER TOGETHER



YOUR PIZZA HUB

SUPERTOP 435/2

2-komorowy elektryczny piec do pizzy sterowany dotykowo



PARAMETRY TECHNICZNE

Napięcie zasilania	V	400
Moc całkowita	kW	16,8
Moc komory	kW	8,4
Wymiary szer. x gł. x wys. + komin	mm	1083x1165x780/+190
Wymiary komory pieczenia szer. x gł. x wys.	mm	759x738x140
Ilość komór pieczenia	szt.	2
Temperatura maksymalna	°C	450
Waga netto	kg	322
Waga brutto	kg	362
Wymiary opakowania	mm	1330x1250x1120

WYDAJNOŚĆ

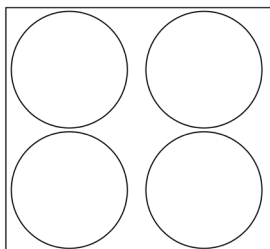

4 pizze ϕ 35 - 40/h

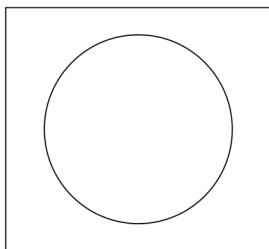

1 pizza ϕ 45 - 6/h

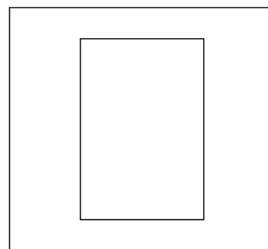

1 taca 600x400 - 4/h

WYMIARY

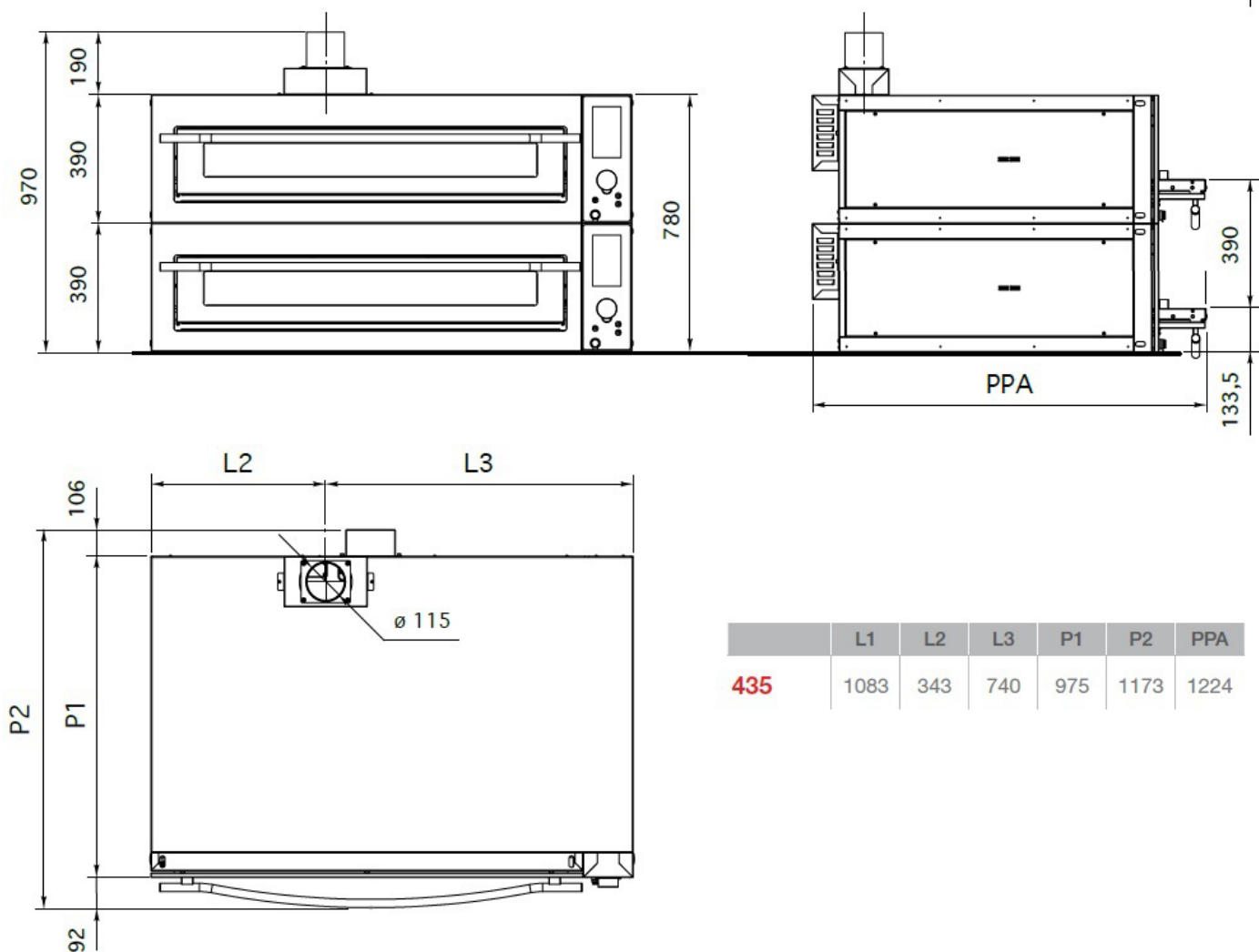

	L1	L2	L3	P1	P2	PPA
435	1083	343	740	975	1173	1224